

Eltorque HDQ3000

Hydraulic double acting actuator (Quarter-turn)

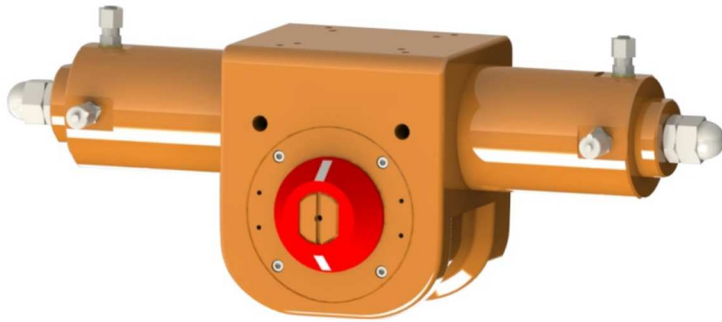

Main Data

HDQ3000	
Valve applications	Butterfly and ball valve (Quarter-turn valve)
PHYSICAL PROPERTIES	
Design	Simple piston rack and pinion design
Dry weight	70kg
Oil connection	BSP1/4"- $\Phi 8/\Phi 10/\Phi 12$
Mounting flange	According to ISO5211 standard
Application	Dry area or submerged area
OPERATING CONDITIONS	
Recommended working pressure range	70-160 bar
Oil displacement	0.45L
Operating temperature	Standard: -30°C-- +60°C
Travel adjustment	90° \pm 5°
Hydraulic oil	Viscosity range: 15 - 64 cSt.
Indication	Open/close on shaft
Closing direction	Clockwise
MOUNTING AND OPERATING STANDARD	
Bottom mounting connection is designed in accordance with ISO5211 standard for direct mounting with valve gear boxes or mounting bracket, outgoing shaft of actuator can be adjusted according to stem of valve.	

Main Dimensions

Actuator shown in closed position.

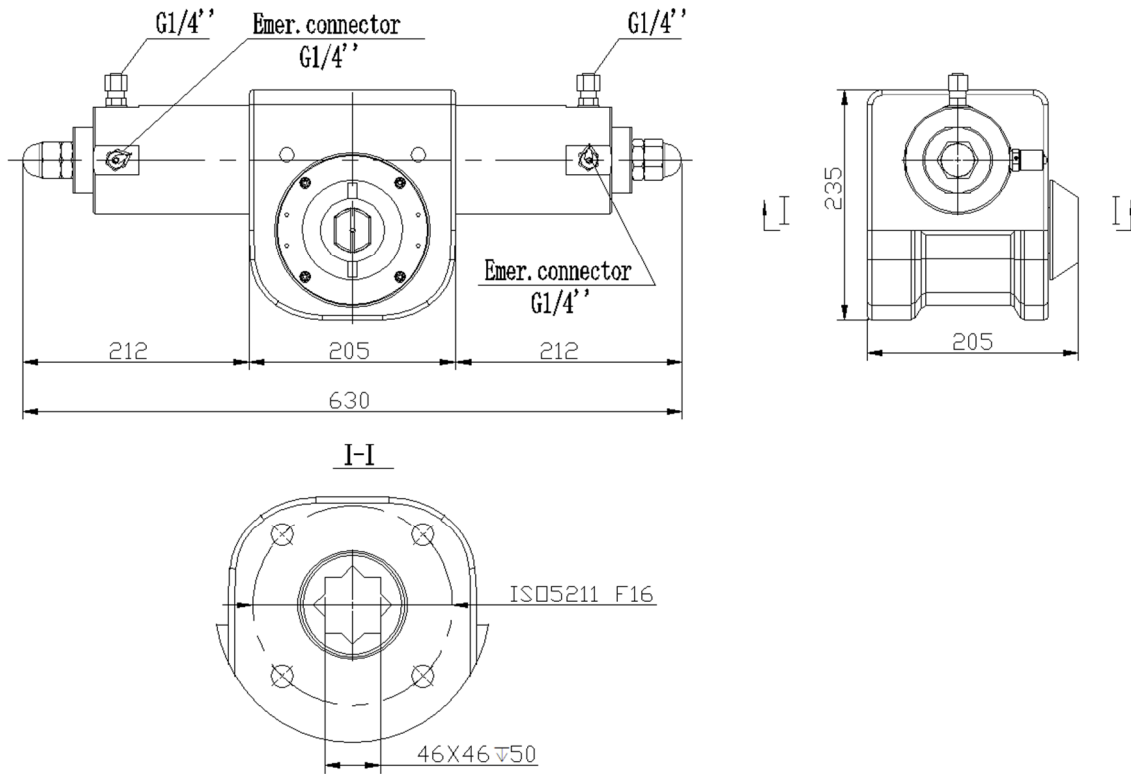

Performance

